



NVR & IPC

ZMD-NR-SAN4

SKU:ZMD-NR-SAN4 / ZMD-NR-SAN8

This network video recorder supports VGA/720P/1080P resolutions to meet the requirements of real-time monitoring needs. Through an optimized H.264 decoding algorithm, even slower networks can provide a real-time HD viewing, recording, and playback experience. A private network transfer protocol is enacted to ensure the security of your transmission. Set your system up anywhere in the world while conveniently and safely monitoring your cameras. With High Definition IP camera products, you have complete digital video surveillance support.

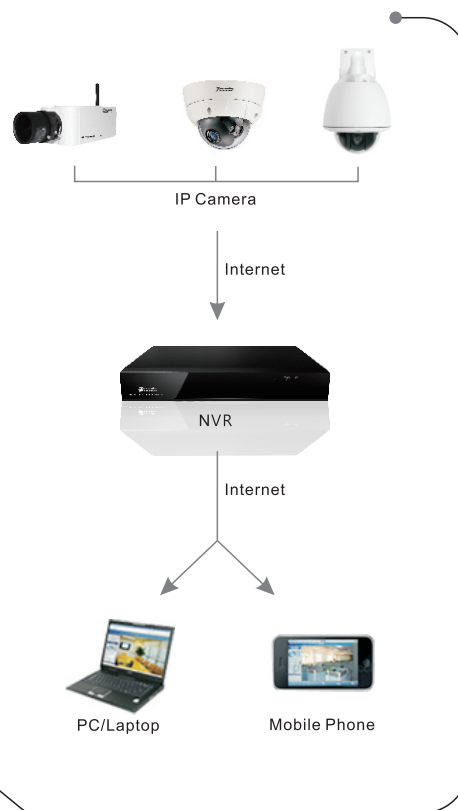
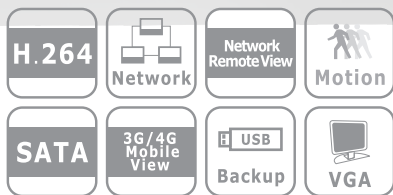

Features And Technical Specifications >>>

Model	Spec	Resolution		Record Rate				Internal HDD Support			Monitors			Audio Inputs / Output				Alarm Inputs / Output			
		CIF Real-time	D1 Real-time	NTSC: 120 fps @ CIF PAL: 100 fps @ CIF	NTSC: 120 fps @ D1 PAL: 100 fps @ D1	NTSC: 240 fps @ CIF PAL: 200 fps @ CIF	NTSC: 480 fps @ D1 PAL: 400 fps @ D1	Real time VGA / 720P	Real time UXGA / 1080P	SATA 1TB	SATA 2TB	SATA 4TB	BNC	VGA	HDMI	1 Input 1 Output	2 Input 1 Output	4 Input 1 Output	4 Input 2 Output	Non Support	4 Input 1 Output
ZMD-NR-SAN4	4CH		•					•	•		•	•			•				•		
ZMD-NR-SAN8	8CH		•					•	•		•	•			•					•	
Video Compression > H.264								Smart Phone Support > iOS, Android, Symbian,Blackberry													

ZMD-NR-SDN4

SKU:ZMD-NR-SDN4 / ZMD-NR-SDN8

This network video recorder supports VGA/720P/1080P resolutions to meet the requirements of real-time monitoring needs. Through an optimized H.264 decoding algorithm, even slower networks can provide a real-time HD viewing, recording, and playback experience. A private network transfer protocol is enacted to ensure the security of your transmission. Set your system up anywhere in the world while conveniently and safely monitoring your cameras. With High Definition IP camera products, you have complete digital video surveillance support.

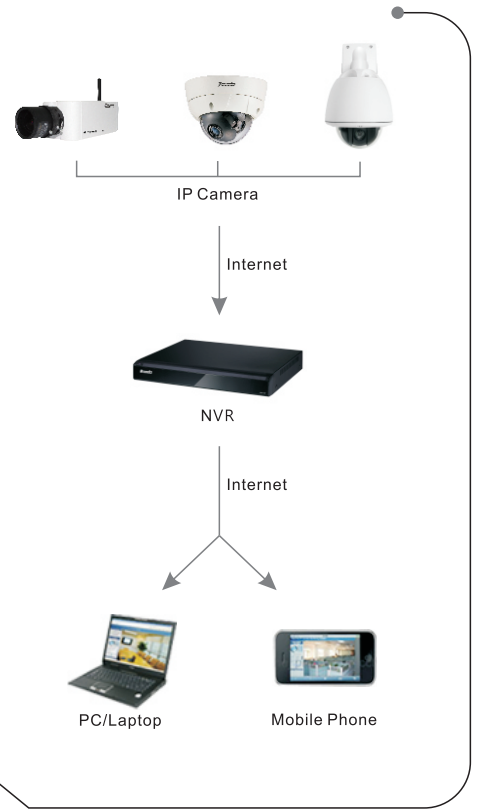
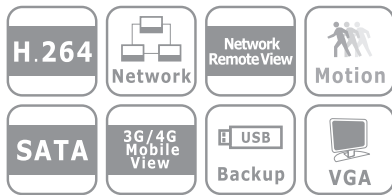

Features And Technical Specifications >>>

Model	Spec	Resolution		Record Rate				Internal HDD Support			Monitors			Audio Inputs / Output				Alarm Inputs / Output			
		CIF Real-time	D1 Real-time	NTSC: 120 fps @ CIF PAL: 100 fps @ CIF	NTSC: 120 fps @ D1 PAL: 100 fps @ D1	NTSC: 240 fps @ CIF PAL: 200 fps @ CIF	NTSC: 480 fps @ D1 PAL: 400 fps @ D1	Real time VGA / 720P	Real time UXGA / 1080P	SATA 1TB	SATA 2TB	SATA 4TB	BNC	VGA	HDMI	1 Input 1 Output	2 Input 1 Output	4 Input 1 Output	4 Input 2 Output	Non Support	4 Input 1 Output
ZMD-NR-SDN4	4CH	•					•		•			•	•			•			•		
ZMD-NR-SDN8	8CH	•					•		•			•	•			•				•	

Video Compression > H.264

Smart Phone Support > iOS, Android, Symbian,Blackberry

ZMD-NR-SEN4

SKU:ZMD-NR-SEN4 / ZMD-NR-SEN8

Designed for home or small business use. Customizable product size, user control and functions with full digital support. Selectable VGA/720P resolutions for clear live view and playback, and special features like privacy setting and motion detection. Upgraded product hardware provides excellent performance and reliability.

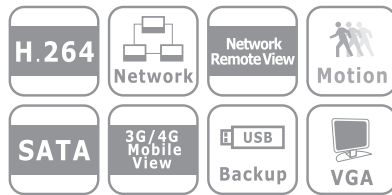
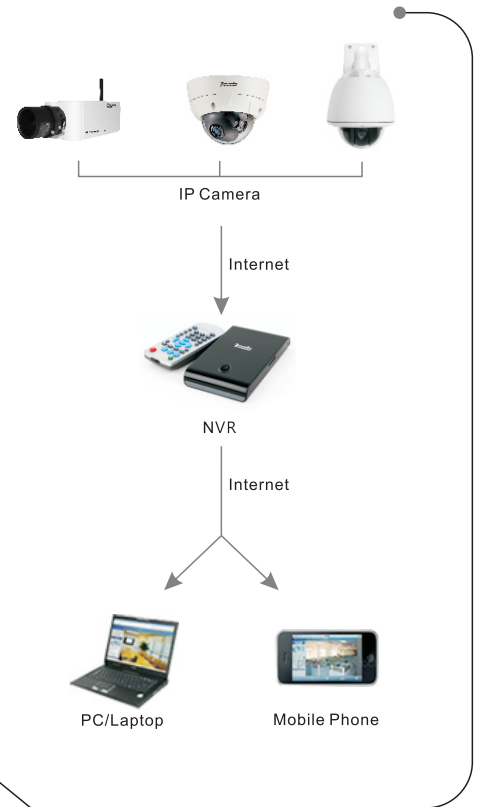

Features And Technical Specifications >>>

		Resolution		Record Rate				Internal HDD Support			Monitors			Audio Inputs / Output				Alarm Inputs / Output				
Model	Spec	CIF	D1	NTSC: 120 fps @ CIF PAL: 100 fps @ CIF	NTSC: 120 fps @ D1 PAL: 100 fps @ D1	NTSC: 240 fps @ CIF PAL: 200 fps @ CIF	NTSC: 480 fps @ D1 PAL: 400 fps @ D1	Real time VGA / 720P	Real time UXGA / 1080P	SATA 1TB	SATA 2TB	SATA 4TB	BNC	VGA	HDMI	1 Input 1 Output	2 Input 1 Output	4 Input 1 Output	4 Input 2 Output	Non Support	4 Input 1 Output	8 Input 1 Output
		ZMD-NR-SEN4	4CH	•					•		•			•	•		•				•	
ZMD-NR-SEN8	8CH		•				•		•			•	•		•					•		
Video Compression > H.264									Smart Phone Support > iOS, Android, Symbian,Blackberry													

ZMD-NR-SFN4

SKU:ZMD-NR-SFN4 / ZMD-NR-SFN8

Combination of intelligent management system and IP network features. Supports VGA/720P resolutions for clear live view and playback. Compact hardware design provides full surveillance feature support. Multiple audio inputs and alarm functions allow you to customize the unit to your specific needs.

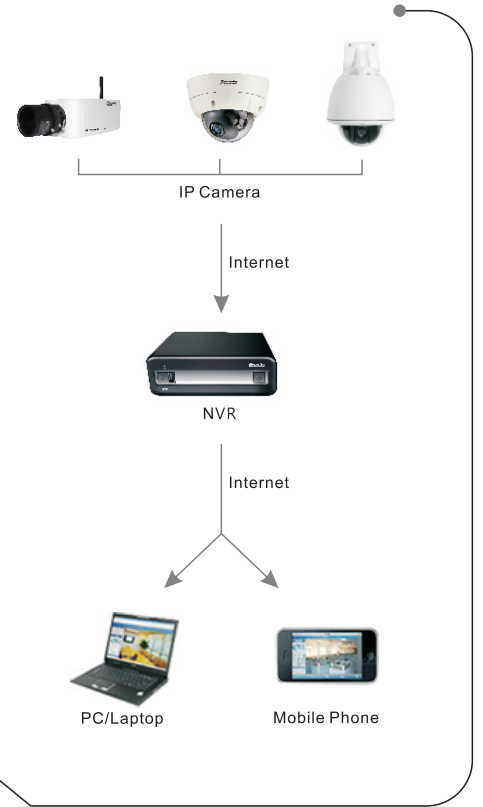

Features And Technical Specifications >>>

		Resolution		Record Rate				Internal HDD Support			Monitors			Audio Inputs / Output				Alarm Inputs / Output				
Model	Spec	CIF	D1	NTSC: 120 fps @ CIF PAL: 100 fps @ CIF	NTSC: 120 fps @ D1 PAL: 100 fps @ D1	NTSC: 240 fps @ CIF PAL: 200 fps @ CIF	NTSC: 480 fps @ D1 PAL: 400 fps @ D1	Real time VGA / 720P	Real time UXGA / 1080P	SATA 1TB	SATA 2TB	SATA 4TB	BNC	VGA	HDMI	1 Input 1 Output	2 Input 1 Output	4 Input 1 Output	4 Input 2 Output	Non Support	4 Input 1 Output	8 Input 1 Output
		ZMD-NR-SFN4	4CH	•					•		•			•	•			•			•	
ZMD-NR-SFN8	8CH		•				•		•			•	•			•				•		
Video Compression > H.264									Smart Phone Support > iOS, Android, Symbian,Blackberry													

ZMD-NH-SHN8

SKU:ZMD-NH-SHN8 / ZMD-NH-SHN6 / ZMD-NH-SHN2

Professional-grade full HD digital surveillance system. Supports VGA/720P/1080P resolutions for clear live view and playback. With support for any surveillance application, customize a variety of features on individual channels. Multiple audio inputs and alarm functions allow you to customize the unit to your specific needs.

Industrial-level manufacturing and quality control ensures stability. Supports most IP camera protocols, provides convenient installation and optimizes cost efficiency. Enabled for full HD video surveillance.

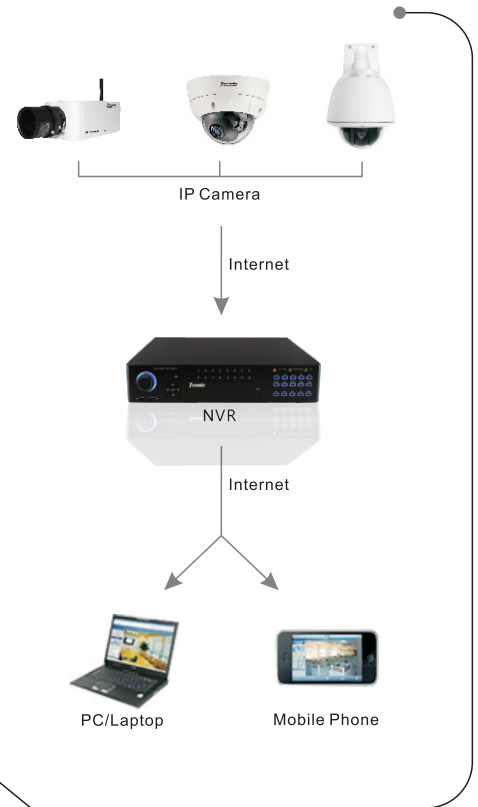

Features And Technical Specifications >>>

Model	Spec	Resolution		Record Rate				Internal HDD Support			Monitors			Audio Inputs / Output				Alarm Inputs / Output				
		CIF Real-time	D1 Real-time	NTSC: 120 fps @ CIF PAL: 100 fps @ CIF	NTSC: 120 fps @ D1 PAL: 100 fps @ D1	NTSC: 240 fps @ CIF PAL: 200 fps @ CIF	NTSC: 480 fps @ D1 PAL: 400 fps @ D1	Real time VGA / 720P	Real time UXGA / 1080P	SATA 1TB	SATA 2TB	SATA 4TB	BNC	VGA	HDMI	1 Input 1 Output	2 Input 1 Output	4 Input 1 Output	4 Input 2 Output	Non Support	4 Input 1 Output	8 Input 1 Output
ZMD-NH-SHN8	8CH	•					•		•			•	•	•		•				•		
ZMD-NH-SHN6	16CH		•				•			•		•	•	•			•				•	
ZMD-NH-SHN2	32CH		•				•			•		•	•	•				•				•
Video Compression > H.264								Smart Phone Support > iOS, Android, Symbian,Blackberry														

ZMD-ISV-DHM23NM

SKU:ZMD-ISV-DHM23NM / ZMD-ISS-DHM23NM / ZMD-ISE-DHM23NM

This high definition network digital camera supports VGA/720P/1080P resolution applications. Running proprietary CMS software, the unit can be connected over the network to provide real-time multi-screen browsing, recording and playback. The hemispherical shape is suited for installation in any room while the IR infrared night vision ensures proper function in even no light situations.

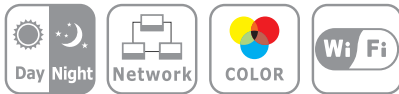

IP CAMERA

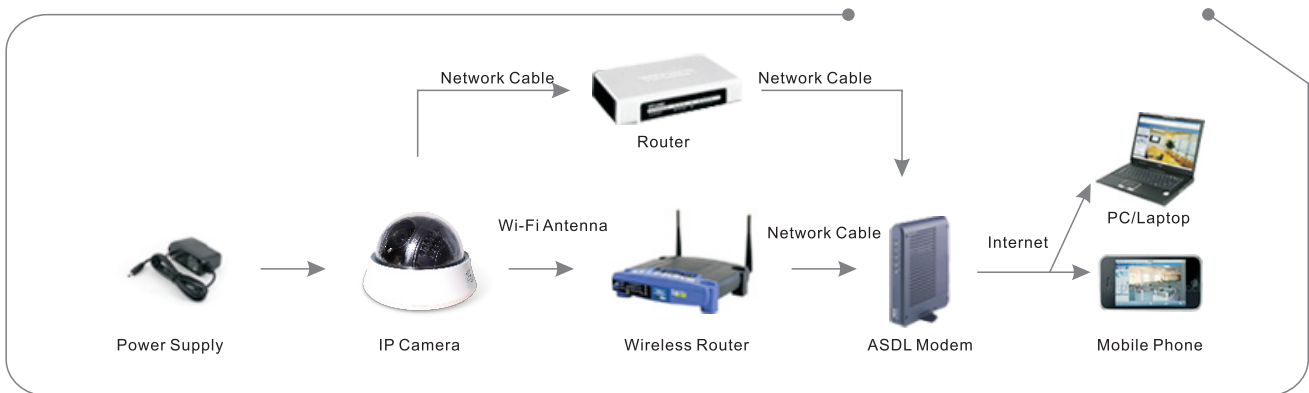

Features And Technical Specifications >>>

Model	Sensor		TV Line				Lens						Signal		IR					Audio					
	OV7752	OV7959	VGA	720P	1080P	3M Pixels	5M Pixels	2.8mm	3.6mm	6mm	12mm	25mm	4-9mm	4-48mm	NTSC	PAL	non IR	10~15cm	20~25cm	30~35cm	40~45cm	60~65cm	Yes	No	
ZMD-ISV-DHM23NM	•		•						•						•				•						•
ZMD-ISS-DHM23NM		•		•					•						•				•						•
ZMD-ISE-DHM23NM		•			•				•						•				•						•
Power Consumption										S / N Ratio															
▶ Max. 3.5W										▶ ≥ 48dB															
Operating Temperature										Input Voltage															
▶ -10 °C to 50 °C										▶ 12V DC ± 10%															

ZMD-ISV-BFS26NM

SKU:ZMD-ISV-BFS26NM / ZMD-ISS-BFS26NM / ZMD-ISE-BFS26NM

Compact body design that is both weather-proof and vandal-proof. Supports WiFi transmission, so no wiring is required for installation or use. The pure digital format supports VGA/720P/1080P resolutions. Transmission sent with encrypted stream algorithm to ensure data security for both wireless and network transmissions. CMS controlled software provides the flexibility of remote multi-channel control from anywhere in the world.

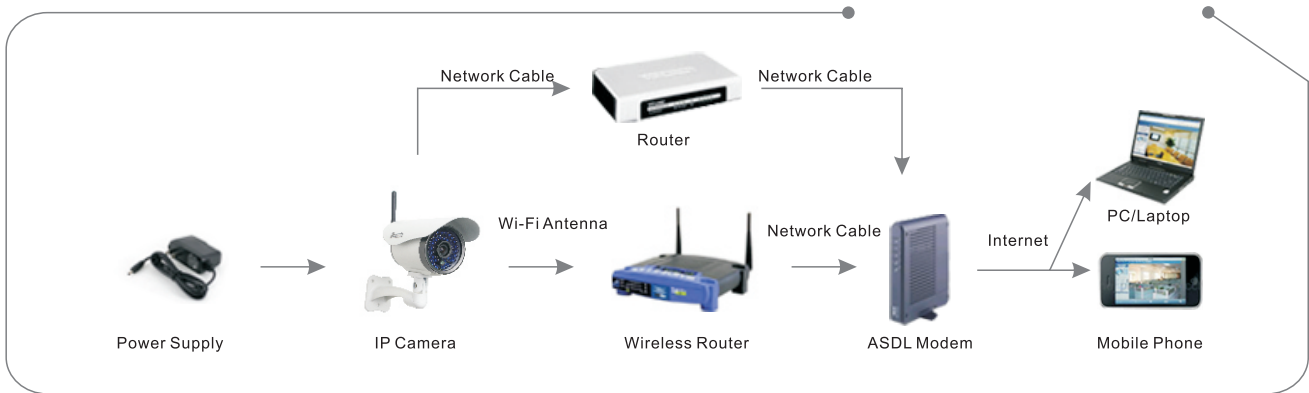
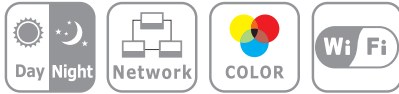

Features And Technical Specifications >>>

Model	Sensor		TV Line				Lens						Signal		IR					Audio				
	OV7752	OV7959	VGA	720P	1080P	3M Pixels	5M Pixels	2.8mm	3.6mm	6mm	12mm	25mm	4-9mm	4-48mm	NTSC	PAL	non IR	10~15cm	20~25cm	30~35cm	40~45cm	60~65cm	Yes	No
ZMD-ISV-BFS26NM	•		•						•						•				•					•
ZMD-ISS-BFS26NM		•		•						•					•				•					•
ZMD-ISE-BFS26NM		•			•					•					•				•					•
Power Consumption										S / N Ratio														
▶ Max. 3.5W										▶ ≥ 48dB														
Operating Temperature										Input Voltage														
▶ -10 °C to 50 °C										▶ 12V DC ± 10%														

ZMD-ISV-DIS13NM

SKU:ZMD-ISV-DIS13NM / ZMD-ISS-DIS13NM / ZMD-ISE-DIS13NM

Indoor network camera with pan tilt functions and cruise capability. WiFi capable for easy installation and use. Using the dedicated CMS software, view and control multiple units from the same screen via the internet. Supports VGA/720P/1080P resolutions.

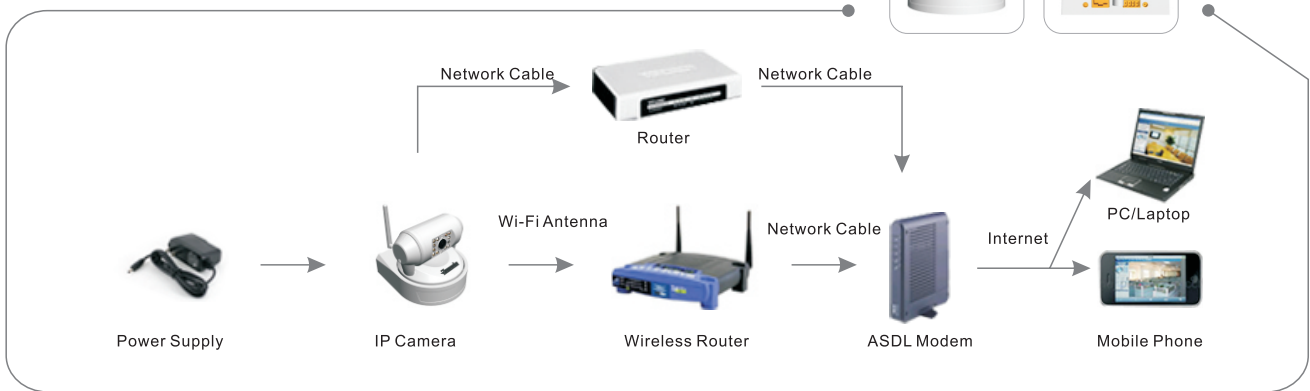
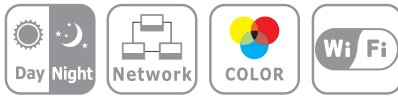

Features And Technical Specifications >>>

Model	Sensor		TV Line				Lens						Signal		IR					Audio				
	OV7752	OV7959	VGA	720P	1080P	3M Pixels	5M Pixels	2.8mm	3.6mm	6mm	12mm	25mm	4-9mm	4-48mm	NTSC	PAL	non IR	10~15cm	20~25cm	30~35cm	40~45cm	60~65cm	Yes	No
ZMD-ISV-DIS13NM	•		•					•							•			•						•
ZMD-ISS-DIS13NM		•		•					•						•			•						•
ZMD-ISE-DIS13NM		•			•				•						•			•						•
Power Consumption										S / N Ratio														
▶ Max. 3.5W										▶ ≥ 48dB														
Operating Temperature										Input Voltage														
▶ -10 °C to 50 °C										▶ 12V DC ± 10%														

ZMD-ISV-BDM26NM

SKU:ZMD-ISV-BDM26NM / ZMD-ISS-BDM26NM / ZMD-ISE-BDM26NM

Compact body design that is both weatherproof and vandal-proof. Supports WiFi transmission, so no wiring is required for installation or use. The pure digital format supports VGA/720P/1080P resolutions. Transmission sent with encrypted stream algorithm to ensure data security for both wireless and network transmissions. CMS controlled software provides the flexibility of remote multi-channel control from anywhere in the world.

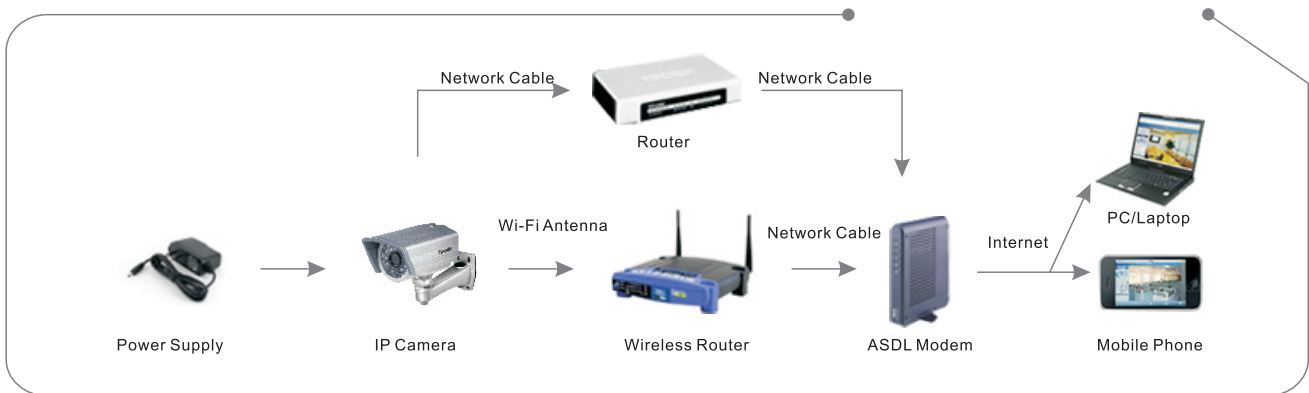
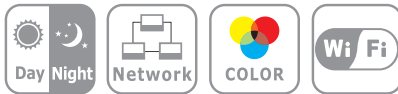

Features And Technical Specifications >>>

Model	Sensor		TV Line				Lens						Signal		IR					Audio					
	OV7752	OV7959	VGA	720P	1080P	3M Pixels	5M Pixels	2.8mm	3.6mm	6mm	12mm	25mm	4-9mm	4-48mm	NTSC	PAL	non IR	10~15cm	20~25cm	30~35cm	40~45cm	60~65cm	Yes	No	
ZMD-ISV-BDM26NM	•		•						•						•				•					•	
ZMD-ISS-BDM26NM		•		•						•					•				•						•
ZMD-ISE-BDM26NM		•			•					•					•				•						•
Power Consumption										S / N Ratio															
▶ Max. 3.5W										▶ ≥ 48dB															
Operating Temperature										Input Voltage															
▶ -10 °C to 50 °C										▶ 12V DC ± 10%															

ZMD-ISV-DDM23NM

SKU:ZMD-ISV-DDM23NM / ZMD-ISS-DDM23NM / ZMD-ISE-DDM23NM

HD dome network digital camera with selectable VGA/720P/1080P resolutions. This camera can be applied toward any indoor use. With the CMS software, real-time monitoring and management of multiple cameras can be done over the network. Mobile viewing from iOS, Android, Symbian, Blackberry and various other supported devices is provided through the web client.

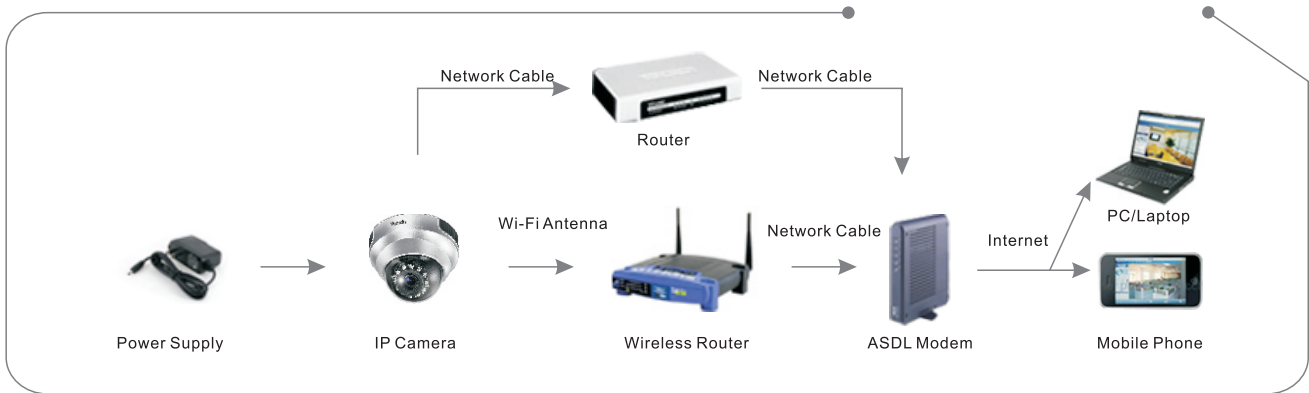
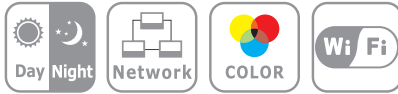

IP CAMERA

Features And Technical Specifications >>>

Model	Sensor		TV Line				Lens						Signal		IR					Audio						
	OV7752	OV7959	VGA	720P	1080P	3M Pixels	5M Pixels	2.8mm	3.6mm	6mm	12mm	25mm	4-9mm	4-48mm	NTSC	PAL	non IR	10~15cm	20~25cm	30~35cm	40~45cm	60~65cm	Yes	No		
ZMD-ISV-DDM23NM	•		•					•							•				•					•		
ZMD-ISS-DDM23NM		•		•					•						•				•						•	
ZMD-ISE-DDM23NM		•			•				•						•				•						•	
Power Consumption										S / N Ratio																
▶ Max. 3.5W										▶ ≥ 48dB																
Operating Temperature										Input Voltage																
▶ -10 °C to 50 °C										▶ 12V DC ± 10%																

ZMD-ISV-BKM06NM

SKU:ZMD-ISV-BKM06NM / ZMD-ISS-BKM06NM / ZMD-ISE-BKM06NM

HD bullet network digital camera with selectable VGA/720P/1080P resolutions. IP66 safety rating to provide the most reliable security in any environment. WiFi capable for easy installation and use. Using the dedicated CMS software, view and control multiple units from the same screen via Internet. Mobile viewing from iOS, Android, Symbian, Blackberry, and various other supported devices is provided through the web client.

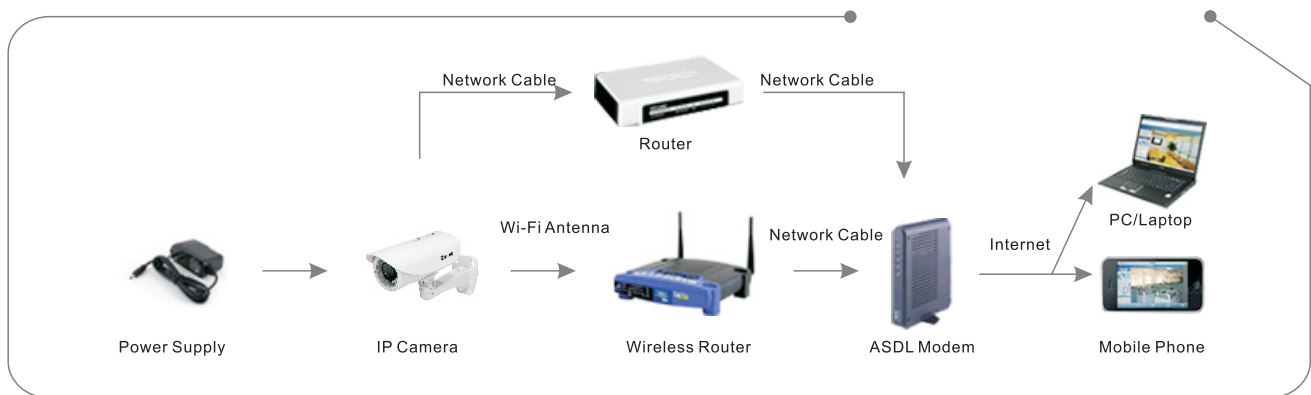
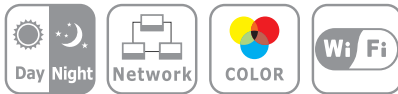

Features And Technical Specifications >>>

Model	Sensor		TV Line				Lens						Signal		IR					Audio				
	OV7752	OV7959	VGA	720P	1080P	3M Pixels	5M Pixels	2.8mm	3.6mm	6mm	12mm	25mm	4-9mm	4-48mm	NTSC	PAL	non IR	10~15cm	20~25cm	30~35cm	40~45cm	60~65cm	Yes	No
ZMD-ISV-BKM06NM	•		•							•					•		•							•
ZMD-ISS-BKM06NM		•		•						•					•		•							•
ZMD-ISE-BKM06NM		•			•					•					•		•							•
Power Consumption										S / N Ratio														
▶ Max. 3.5W										▶ ≥ 48dB														
Operating Temperature										Input Voltage														
▶ -10 °C to 50 °C										▶ 12V DC ± 10%														

ZMD-ISV-BLM06NM

SKU:ZMD-ISV-BLM06NM / ZMD-ISS-BLM06NM / ZMD-ISE-BLM06NM

HD bullet network digital camera with selectable VGA/720P/1080P resolutions. IP66 safety rating to provide the most reliable security in any environment. WiFi capable for easy installation and use. Using the dedicated CMS software, viewand control multiple units from the same screen via Internet. Mobile viewing from iOS,Android, Symbian, Blackberry, and various other supported devices is provided through the web client.

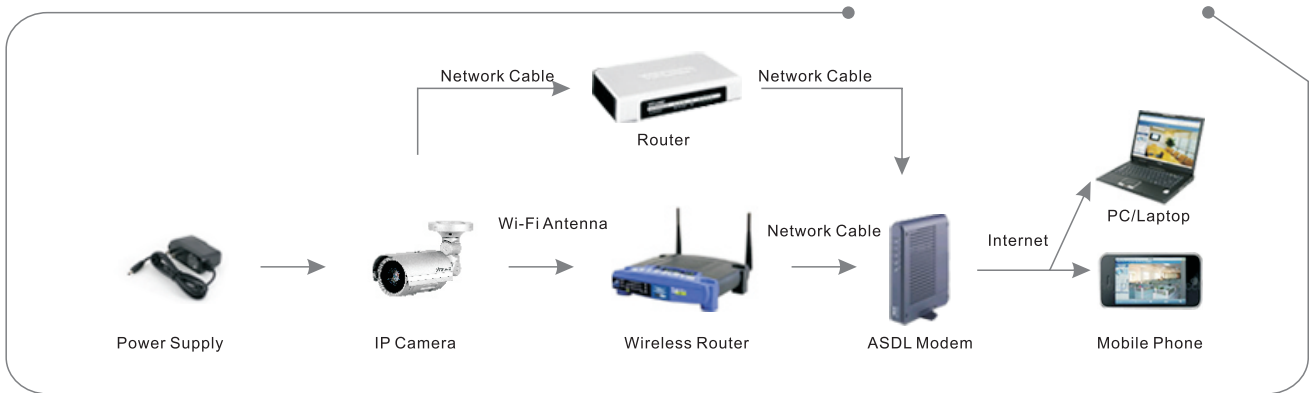
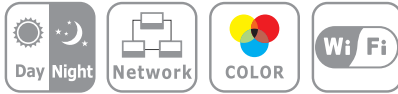

Features And Technical Specifications >>>

Model	Sensor		TV Line				Lens						Signal		IR					Audio				
	OV7752	OV7959	VGA	720P	1080P	3M Pixels	5M Pixels	2.8mm	3.6mm	6mm	12mm	25mm	4-9mm	4-48mm	NTSC	PAL	non IR	10~15cm	20~25cm	30~35cm	40~45cm	60~65cm	Yes	No
ZMD-ISV-BLM06NM	•		•						•						•		•							•
ZMD-ISS-BLM06NM		•		•						•					•		•							•
ZMD-ISE-BLM06NM		•			•					•					•		•							•
Power Consumption										S / N Ratio														
▶ Max. 3.5W										▶ ≥ 48dB														
Operating Temperature										Input Voltage														
▶ -10 °C to 50 °C										▶ 12V DC ± 10%														

ZMD-ISV-BFM26NM

SKU:ZMD-ISV-BFM26NM / ZMD-ISS-BFM26NM / ZMD-ISE-BFM26NM

HD bullet network digital camera with selectable VGA/720P/1080P resolutions. IP66 safety rating to provide the most reliable security in any environment. WiFi capable for easy installation and use. Using the dedicated CMS software, view and control multiple units from the same screen via Internet. Mobile viewing from iOS, Android, Symbian, Blackberry, and various other supported devices is provided through the web client.

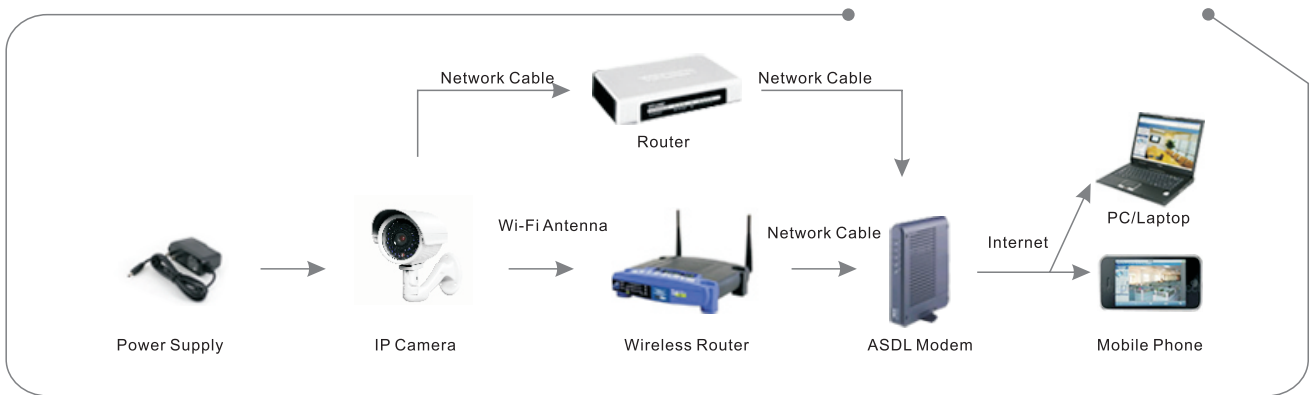
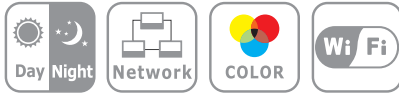

Features And Technical Specifications >>>

Model	Sensor		TV Line				Lens						Signal		IR					Audio						
	OV7752	OV7959	VGA	720P	1080P	3M Pixels	5M Pixels	2.8mm	3.6mm	6mm	12mm	25mm	4-9mm	4-48mm	NTSC	PAL	non IR	10~15cm	20~25cm	30~35cm	40~45cm	60~65cm	Yes	No		
ZMD-ISV-BFM26NM	•		•						•						•				•					•		
ZMD-ISS-BFM26NM		•		•						•					•				•					•		
ZMD-ISE-BFM26NM		•			•					•					•				•					•		
Power Consumption										▶ Max. 3.5W					S / N Ratio										▶ ≥ 48dB	
Operating Temperature										▶ -10 °C to 50 °C					Input Voltage										▶ 12V DC ± 10%	

ZMD-ISV-BMM31NM

SKU:ZMD-ISV-BMM31NM / ZMD-ISS-BMM31NM / ZMD-ISE-BMM31NM

HD bullet network digital camera with selectable VGA/720P/1080P resolutions. IP66 safety rating to provide the most reliable security in any environment. WiFi capable for easy installation and use. Using the dedicated CMS software, view and control multiple units from the same screen via Internet. Mobile viewing from iOS, Android, Symbian, Blackberry, and various other supported devices is provided through the web client.

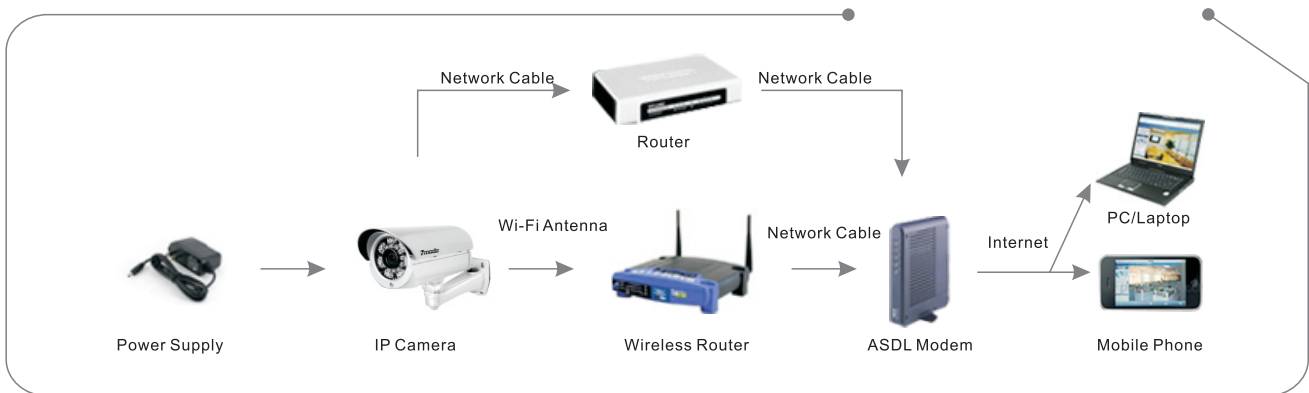
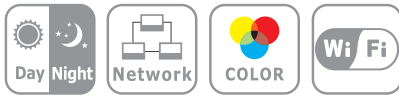

IP CAMERA

Features And Technical Specifications >>>

Model	Sensor		TV Line					Lens				Signal		IR					Audio																				
	OV7752	OV7959	VGA	720P	1080P	3M Pixels	5M Pixels	2.8mm	3.6mm	6mm	12mm	25mm	4-9mm	4-48mm	NTSC	PAL	non IR	10~15cm	20~25cm	30~35cm	40~45cm	60~65cm	Yes	No															
ZMD-ISV-BMM31NM	•		•							•					•					•				•															
ZMD-ISS-BMM31NM		•		•						•					•					•				•															
ZMD-ISE-BMM31NM		•			•					•					•					•				•															
Power Consumption										S / N Ratio					▶ Max. 3.5W										▶ ≥ 48dB														
Operating Temperature										Input Voltage										▶ -10 °C to 50 °C										▶ 12V DC ± 10%									

ZMD-ISV-DEL23NM

SKU:ZMD-ISV-DEL23NM / ZMD-ISS-DEL23NM / ZMD-ISE-DEL23NM

This high definition network digital camera supports VGA/720P/1080P resolution applications. Running proprietary CMS software, the unit can be connected over the network to provide real-time multi-screen browsing, recording and playback. The hemispherical shape is suited for installation in any room while the IR infrared night vision ensures proper function in even no light situations.

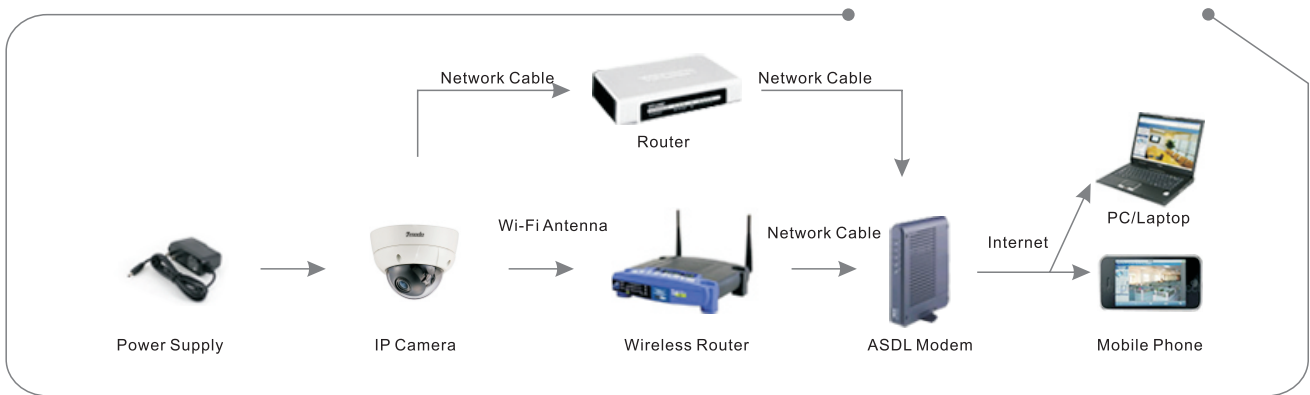
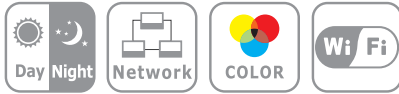

Features And Technical Specifications >>>

Model	Sensor		TV Line				Lens						Signal		IR					Audio				
	OV7752	OV7959	VGA	720P	1080P	3M Pixels	5M Pixels	2.8mm	3.6mm	6mm	12mm	25mm	4-9mm	4-48mm	NTSC	PAL	non IR	10~15cm	20~25cm	30~35cm	40~45cm	60~65cm	Yes	No
ZMD-ISV-DEL23NM	•		•				•	•							•				•					•
ZMD-ISS-DEL23NM		•		•											•				•					•
ZMD-ISE-DEL23NM		•			•										•				•					•
Power Consumption										S / N Ratio														
▶ Max. 3.5W										▶ ≥ 48dB														
Operating Temperature										Input Voltage														
▶ -10 °C to 50 °C										▶ 12V DC ± 10%														

ZMD-ISV-ZEL42NM

SKU:ZMD-ISV-ZEL42NM / ZMD-ISS-ZEL42NM / ZMD-ISE-ZEL42NM

HD IP network speed dome features selectable VGA/720P/1080P resolutions. Longer distance viewing utilizing the optical and digital zoom. PTZ and cruise functions ensure complete control and surveillance. WiFi capable for easy installation and use. Using the dedicated CMS software, view and control multiple units from the same screen via Internet. Mobile viewing from iOS, Android, Symbian, Blackberry, and various other supported devices is provided through the web client. PTZ Cameras.

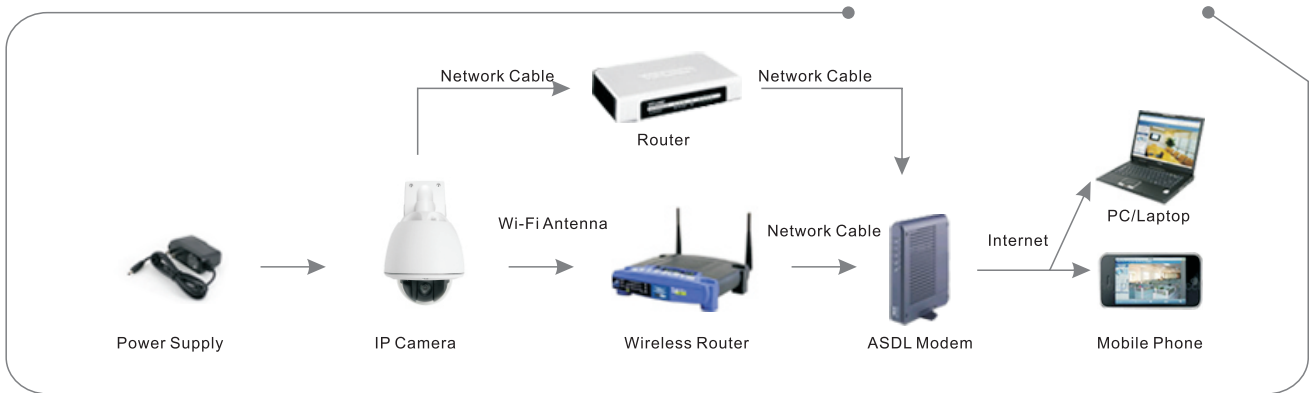

IP CAMERA

Features And Technical Specifications >>>

Model	Sensor		TV Line				Lens						Signal		IR					Audio							
	OV7752	OV7959	VGA	720P	1080P	3M Pixels	5M Pixels	2.8mm	3.6mm	6mm	12mm	25mm	4-9mm	4-48mm	NTSC	PAL	non IR	10~15cm	20~25cm	30~35cm	40~45cm	60~65cm	Yes	No			
ZMD-ISV-ZEL42NM	•		•								•				•						•			•			
ZMD-ISS-ZEL42NM		•		•								•			•						•			•			
ZMD-ISE-ZEL42NM		•			•						•				•						•			•			
Power Consumption											▶ Max. 3.5W													S / N Ratio		▶ ≥ 48dB	
Operating Temperature											▶ -10 °C to 50 °C													Input Voltage		▶ 12V DC ± 10%	



DVR

ZMD-DR-SAN4

SKU:ZMD-DR-SAN4 / ZMD-DR-SAN8

A combination of performance and reliability, this unit is designed for home and small business users. H.264 decoding algorithm provides high image quality with minimal bandwidth requirement for live monitoring and long distance network viewing. Steady and clear image quality tops our current product line. Mobile viewing function supports popular platforms such as iOS, Android, Symbian and Blackberry.

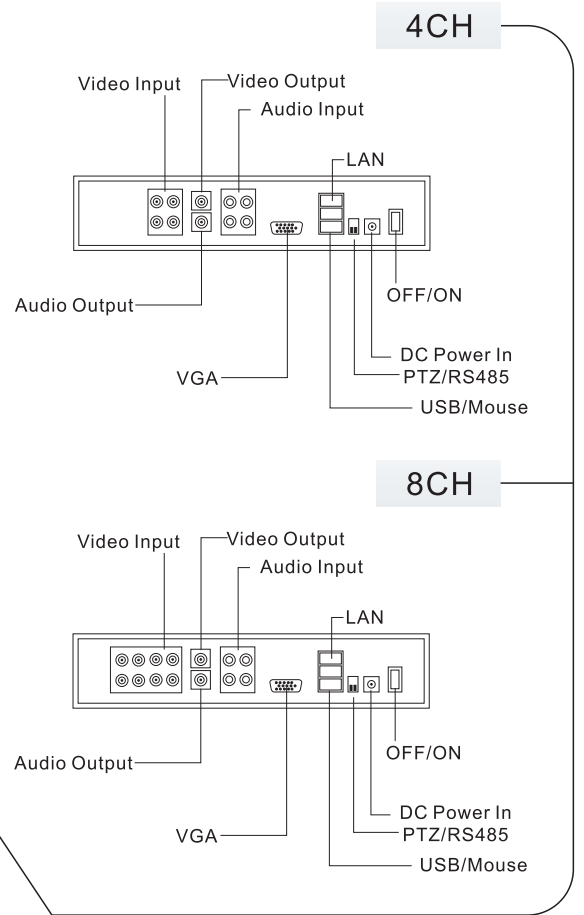
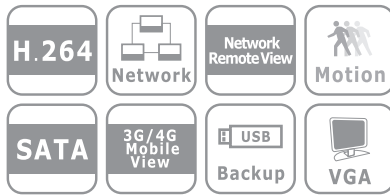

Features And Technical Specifications ▶▶

Model	Spec	Resolution		Record Rate				Internal HDD Support			Monitors			Audio Inputs / Output				Alarm Inputs / Output			
		CIF Real-time	D1 Real-time	NTSC: 120 fps @ CIF PAL: 100 fps @ CIF	NTSC: 120 fps @ D1 PAL: 100 fps @ D1	NTSC: 240 fps @ CIF PAL: 200 fps @ CIF	NTSC: 480 fps @ D1 PAL: 400 fps @ D1	Real time VGA / 720P	Real time UXGA / 1080P	SATA 1TB	SATA 2TB	SATA 4TB	BNC	VGA	HDMI	1 Input 1 Output	2 Input 1 Output	4 Input 1 Output	4 Input 2 Output	Non Support	4 Input 1 Output
ZMD-DR-SAN4	4CH		•		•				•			•	•			•			•		
ZMD-DR-SAN8	8CH	•				•			•			•	•			•				•	

Video Compression ▶ H.264

Smart Phone Support ▶ iOS, Android, Symbian, Blackberry

DIGITAL VIDEO RECORDER

ZMD-DR-SBN4

SKU:ZMD-DR-SBN4 / ZMD-DR-SBN8 / ZMD-DR-SBN6

Provides a complete full coverage of video monitoring with alarm function. Real-time multi-channel viewing, recording, and playback support. Network access allows users to monitor from anywhere in the world via PC client software, to stay connected on real-time events. Multiple audio inputs and alarm functions allow you to customize the unit to your specific needs. 16ch system supports HDMI video connection for HD viewing and playback.

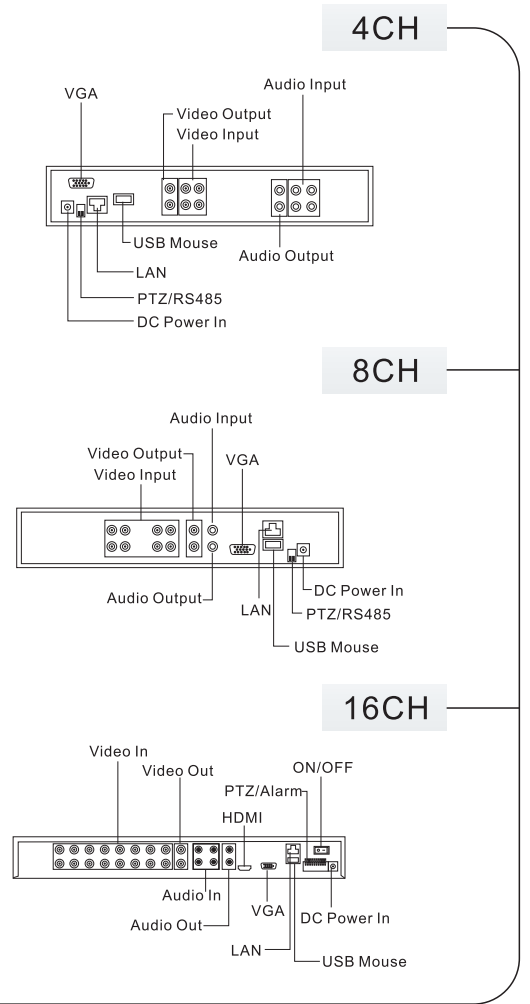
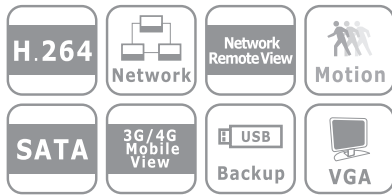

Features And Technical Specifications >>>

Model	Spec	Resolution		Record Rate				Internal HDD Support			Monitors			Audio Inputs / Output				Alarm Inputs / Output			
		CIF Real-time	D1 Real-time	NTSC: 120 fps @ CIF PAL: 100 fps @ CIF	NTSC: 120 fps @ D1 PAL: 100 fps @ D1	NTSC: 240 fps @ CIF PAL: 200 fps @ CIF	NTSC: 480 fps @ D1 PAL: 400 fps @ D1	Real time VGA / 720P	Real time UXGA / 1080P	SATA 1TB	SATA 2TB	SATA 4TB	BNC	VGA	HDMI	1 Input 1 Output	2 Input 1 Output	4 Input 1 Output	4 Input 2 Output	Non Support	4 Input 1 Output
ZMD-DR-SBN4	4CH	•	•						•			•	•		•				•		
ZMD-DR-SBN4	8CH	•				•				•		•	•				•			•	
ZMD-DR-SBN6	16CH	•				•				•		•	•	•				•		•	

Video Compression > H.264

Smart Phone Support > iOS, Android, Symbian,Blackberry

ZMD-DH-SCN6

SKU:ZMD-DH-SCN6 / ZMD-DH-SCN2

Professional grade surveillance solution with real-time multi-channel view and record capabilities. Simultaneously view, record, playback, and view remotely with multi-function ability. Support for multiple harddisk drives, up to 8TB. High quality components ensure stability. Excellent choice for professional-grade installations.

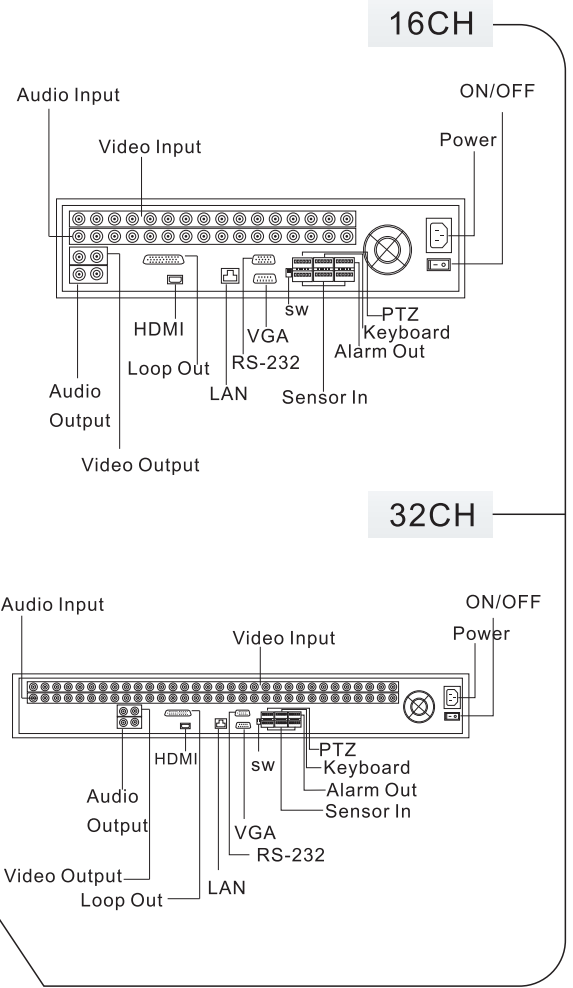
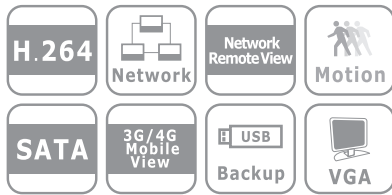

Features And Technical Specifications >>>

Model	Spec	Resolution		Record Rate				Internal HDD Support			Monitors			Audio Inputs / Output				Alarm Inputs / Output			
		CIF Real-time	D1 Real-time	NTSC: 120 fps @ CIF PAL: 100 fps @ CIF	NTSC: 120 fps @ D1 PAL: 100 fps @ D1	NTSC: 240 fps @ CIF PAL: 200 fps @ CIF	NTSC: 480 fps @ D1 PAL: 400 fps @ D1	Real time VGA / 720P	Real time UXGA / 1080P	SATA 1TB	SATA 2TB	SATA 4TB	BNC	VGA	HDMI	1 Input 1 Output	2 Input 1 Output	4 Input 1 Output	4 Input 2 Output	Non Support	4 Input 1 Output
ZMD-DH-SCN6	16CH		•							•	•	•	•			•					•
ZMD-DH-SCN6	32CH	•								•	•	•	•					•			•
Video Compression > H.264								Smart Phone Support > iOS, Android, Symbian,Blackberry													